

Ceratherm T50 Exposed Thermostatic Bath Shower Mixer

ILLUSTRATED

A7224 Ceratherm T50 exposed thermostatic bath shower mixer

ILLUSTRATED PRODUCT DETAILS

Weights

A7224 2.05 KG

Finishes

A7224  Chrome (AA)

Materials

A7224 Chrome Plated Brass

Flow rates

A7224 20 Litres per minute @ 3 bar pressure

Special Notes

Unregulated flow rate 20 litres per minute at 3 bar.
Minimum operating pressure of 0.5 Bar

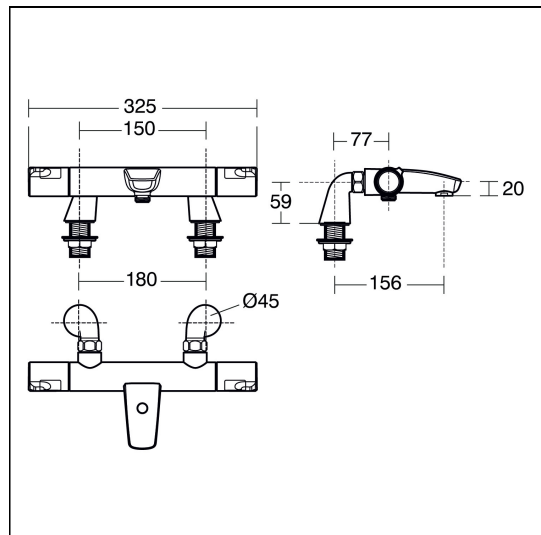

ACCREDITATIONS

FEATURES

