

Sandringham 21 Water Saving Bath 170cm x 70cm 2 Tapholes With Handgrips And Tread Pattern

ILLUSTRATED

- E0288** Sandringham 21 170cm x 70cm 2 taphole water saving bath with chrome plated handgrips and tread pattern
- B3309** Sandringham SL 21 2 hole bath filler
- S1019** Sandringham 21 front bath panel 170cm
- S1020** Sandringham 21 end bath panel 70cm
- S8970** Trap 1½" plastic P with 75mm seal, multi-purpose outlet suitable for plastic and BS copper pipe
- S8830** Waste 1½" bath chain and overflow, plastic plug
- A5901** TMV thermostatic mixing valve, 22mm

ILLUSTRATED PRODUCT DETAILS







Weights

- E0288** 20.00 KG
- B3309** 1.68 KG
- S1019** 3.60 KG
- S1020** 1.80 KG
- S8970** 1.00 KG
- S8830** 1.78 KG
- A5901** 0.60 KG

Materials

- E0288** Idealform
- B3309** Chrome Plated Brass
- S1019** High Impact Polystyrene
- S1020** Acrylic
- S8970** Plastic
- S8830** Mixed Material
- A5901** Chrome Plated Metal

Finishes

- E0288**  White (01)
- B3309**  Chrome (AA)
- S1019**  White (01)
- S1020**  White (01)
- S8970**  Neutral / No Finish (67)
- S8830**  Chrome (AA)
- A5901**  Chrome (AA)

Capacity

- E0288** 139.0 litres (to overflow)

Flow rates

- B3309** 70 Litres per minute @ 3 bar pressure

Standards

Constructed to BS EN 198:2008. EN 14516

Special Notes

The tread pattern on Sandringham 21 acrylic baths should not be considered as a fully anti-slip surface and will not prevent all slipping. Consideration should be given to safe hot water delivery and the use of an appropriate temperature reduction device, see A5901AA or Part G for guidance.

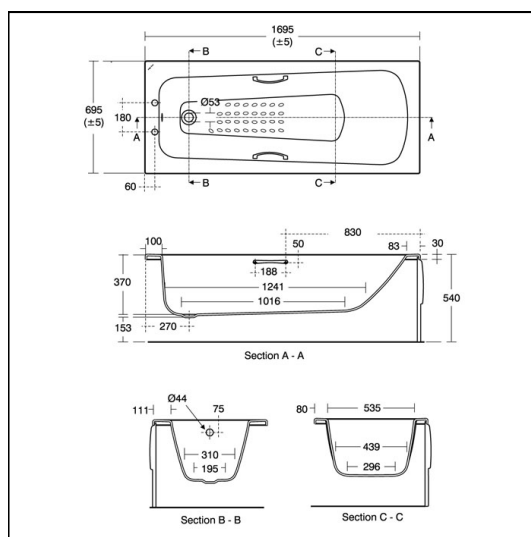

ACCREDITATIONS

E0288(01)

Unified Water Label  139.0 Litres

B3309(AA)

Unified Water Label  70.00 Litres Per Minute

FEATURES

