

Concept 170cm x 85cm Idealform+ Square Shower Bath LH No Taphole

ILLUSTRATED

- E0492** Concept 170cm x 85cm Idealform Plus+ Square shower bath with no tapholes, left hand
- E0504** Concept 170cm Square shower bath front panel
- E3169** Unilux 70cm end panel
- E1486** Luxury bath pop-up waste and overflow
- E0508** Concept Square shower bath screen, clear glass and bright silver finish
- A5901** TMV thermostatic mixing valve, 22mm

OPTIONS

- A7051** Connect Air single lever 2 tap hole bath filler
- BC707** Cerafine O dual control bath filler

ILLUSTRATED PRODUCT DETAILS







Weights

- E0492** 40.30 KG
- E0504** 3.57 KG
- E3169** 2.58 KG
- E0508** 16.10 KG
- A5901** 0.60 KG

Materials

- E0492** Idealform Plus+
- E0504** High Impact Polystyrene
- E3169** High Impact Polystyrene
- E1486** Mixed Material
- E0508** Toughened Safety Glass
- A5901** Chrome Plated Metal

Finishes

- E0492**  White (01)
- E0504**  White (01)
- E3169**  White (01)
- E1486**  Chrome (AA)
- E0508**  Bright Silver (EO)
- A5901**  Chrome (AA)

Designer

Robin Levien, RDI

Standards

Constructed to EN 198:2008. EN 14516

Special Notes

Consideration should be given to safe hot water delivery and the use of an appropriate temperature reduction device, see A5901AA or Part G for guidance. One taphole fittings require offsetting from the overflow. Check positioning and compatibility before specifying. Dedicated front panel and bath screen are unhandled.

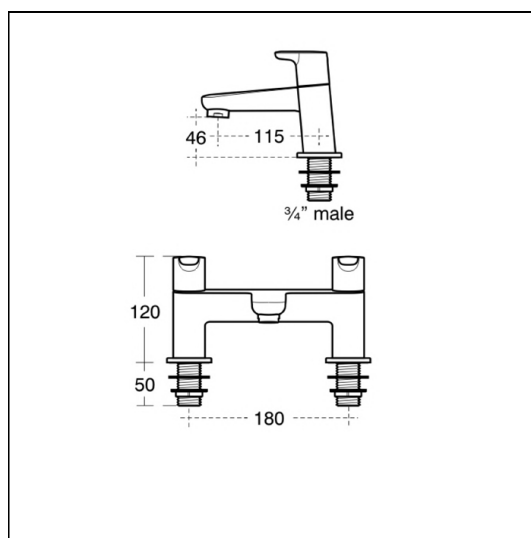

ACCREDITATIONS

A7051(AA)

Unified
Water Label

➔

26.00

Litres
Per
Minute