

Concept Freedom 170cmx80cm Idealform Plus+ Bath, Left Hand

ILLUSTRATED

- E1087** Concept Freedom 170cm x 80cm Idealform Plus+ bath no taphole, with waste, left hand
- E1092** Concept Freedom gel headrest
- A7051** Connect Air single lever 2 tap hole bath filler
- E1096** Concept Freedom 170cm front bath panel
- E1097** Concept Freedom 80cm end bath panel with access panel
- A5901** TMV thermostatic mixing valve, 22mm

OPTIONS

- E1093** Concept Freedom 45cm support rail
- E1094** Concept Freedom 60cm support rail

ILLUSTRATED PRODUCT DETAILS







Weights

- E1087** 34.40 KG
- A7051** 2.83 KG
- E1096** 2.70 KG
- E1097** 1.30 KG
- A5901** 0.60 KG

Materials

- E1087** Idealform Plus+
- E1092** Plastic
- A7051** Chrome Plated Brass
- E1096** High Impact Polystyrene
- E1097** Acrylic
- A5901** Chrome Plated Metal

Finishes

- E1087**  White (01)
- E1092**  Neutral / No Finish (67)
- A7051**  Chrome (AA)
- E1096**  White (01)
- E1097**  White (01)
- A5901**  Chrome (AA)

Capacity

- E1087** 166.0 litres (to overflow)





Flow rates

- A7051** 26 Litres per minute @ 3 bar pressure

Designer

Robin Levien, RDI

FINISH OPTIONS

- 
(AA) Chrome
 - 
(A2) Brushed Gold
 - 
(A5) Magnetic Grey
- 
(GN) Silver Storm

Standards

Constructed to EN 198:2008. EN 14516

Special Notes

Due to lowered height of the baths only Concept Freedom bath panels are compatible with this bath. Consideration should be given to safe hot water delivery and the use of an appropriate temperature reduction

E: info@idealspec.co.uk | T: 0870 122 8822 | F: 0870 122 8282 | www.idealspec.co.uk

Ideal Standard (UK) Ltd. makes every effort to ensure that the information provided on its website is accurate. However, we cannot guarantee this, and accept no liability for any information or advice given via its website.

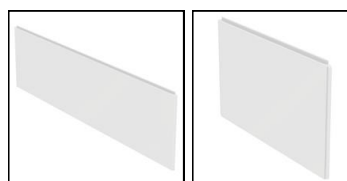
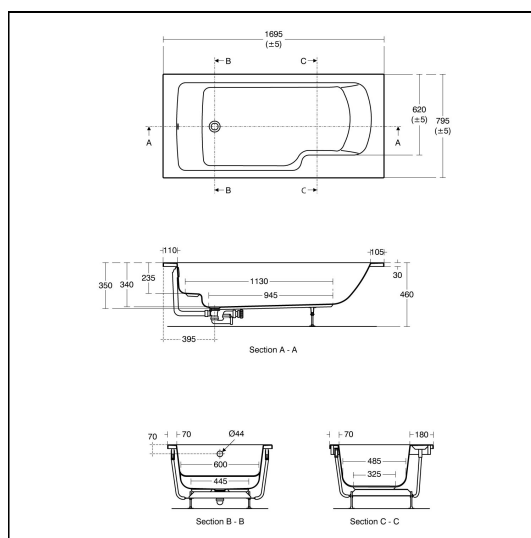

Concept Freedom 170cmx80cm Idealform Plus+ Bath, Left Hand

device, see A5901AA or Part G for guidance. One taphole fittings require offsetting from the overflow. Check positioning and compatibility before specifying.