

# Free Flow Unslotted Waste

## ILLUSTRATED

E2114 Free flow unslotted waste, ceramic

### ILLUSTRATED PRODUCT DETAILS

**Weights**

E2114 0.33 KG













**Finishes**

E2114  White (01)

**Materials**

E2114 Mixed Material

### FINISH OPTIONS

		
(01) White	(V1) Silk White	(V2) Black Glossy
		
(V3) Black Matt	(V4) Kashmir	(V5) Slate Grey
		
(V6) Pomegranate	(V7) Nude	(V8) Mink
		
(V9) Concrete	(X8) Powder	(X9) Sage

**Special Notes**

Unslotted free flow waste, can be used with basins with or without overflows

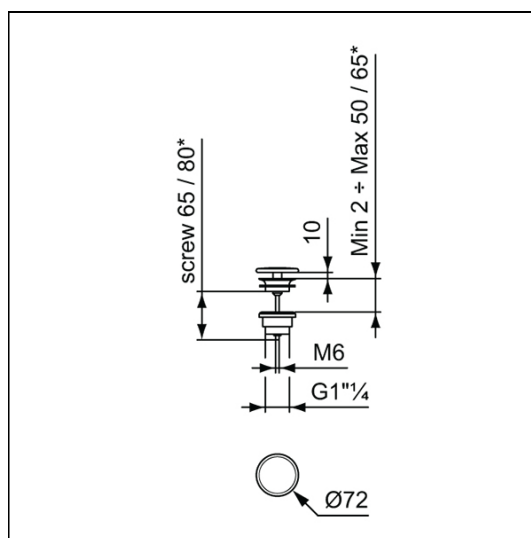

## Free Flow Unslotted Waste

