

Finesse 120cm Wall Mounted Vanity Unit

ILLUSTRATED

- E3394** Finesse 120cm x 50cm wall mounted vanity unit with 2 drawers
- E0157** Wall fixing set
- EE230339** Space saving trap and waste pipe assembly for use with furniture basin units
- T4370** Extra 120cm vanity washbasin, 1 taphole with overflow
- BC799** Joy single lever basin mixer with click waste

OPTIONS

- T4372** Extra 120cm vanity washbasin, 3 tapholes with overflow
- T4373** Extra 120cm vanity washbasin, no taphole with overflow
- T5367** Solos 120cm 1 taphole vanity washbasin, no overflow
- T5368** Solos 120cm 2 taphole vanity washbasin, no overflow
- T5562** Solos 120cm no taphole vanity washbasin, no overflow
- BD683** La Dolce Vita single lever basin mixer with 118mm spout projection and clicker waste

ILLUSTRATED PRODUCT DETAILS

Weights





- E3394** 43.23 KG
- E0157** 0.16 KG
- EE230339** 0.10 KG
- 9**
- T4370** 34.40 KG
- BC799** 0.01 KG

Materials

- E3394** Mixed Material
- E0157** Metal
- EE230339** Plastic
- 9**

- T4370** Fine Fireclay
- BC799** Chrome Plated Brass













Finishes

- E3394**  Matt White (Y1)
- E0157**  Neutral/No Finish (67)
- EE230339**  Neutral/No Finish (67)
- 9**
- T4370**  White (01)
- BC799**  Chrome finish (AA)

Capacity

- T4370** 13.7 litres

FINISH OPTIONS

- | | | |
|---|---|---|
|  |  |  |
| (Y1) Matt White | (Y2) Matt Anthracite | (UP) Matt Griege |
|  |  |  |
| (UQ) Matt Ash Blue | (UR) Dark Elm | (US) White Oak |
|  |  |  |
| (01) White | (V1) Silk White | (A2) Brushed Gold |
|  |  |  |
| (A5) Magnetic Grey | (AA) Chrome finish | (GN) Silver Storm |

Special Notes

Furniture units should be installed in a bathroom with adequate ventilation. Mounting kit included. Always use appropriate fixings to suit the type of wall.

E: info@idealspec.co.uk | T: 0870 122 8822 | F: 0870 122 8282 | www.idealspec.co.uk

Ideal Standard (UK) Ltd. makes every effort to ensure that the information provided on its website is accurate. However, we cannot guarantee this, and accept no liability for any information or advice given via its website.

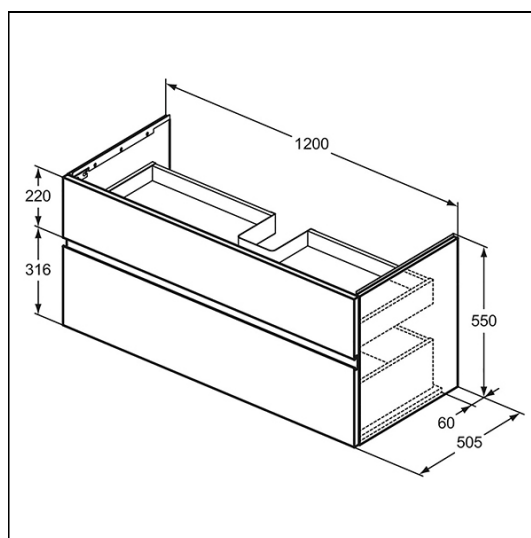

ACCREDITATIONS

