

Finesse 80cm Wall mounted Vanity Unit

ILLUSTRATED

- E3396** Finesse 80cm x 50cm wall mounted vanity unit with 2 drawers
- T4362** Extra 80cm vanity washbasin, 1 taphole with overflow
- E0157** Wall fixing set
- EE230339** Space saving trap and waste pipe assembly for use with furniture basin units
- BC799** Joy single lever basin mixer with click waste

OPTIONS

- E2241** Calla 85cm vanity washbasin, 1 taphole with overflow

ow
- E2242** Calla 85cm vanity washbasin, 2 tapholes with overflow

ow
- E2243** Calla 85cm vanity washbasin, 3 tapholes with overflow

ow
- T4364** Extra 80cm vanity washbasin, 3 tapholes with overflow
- T4365** Extra 80cm vanity washbasin, no taphole with overflow
- T4604** Ideal Standard i.life B 81cm vanity washbasin, 1 taphole

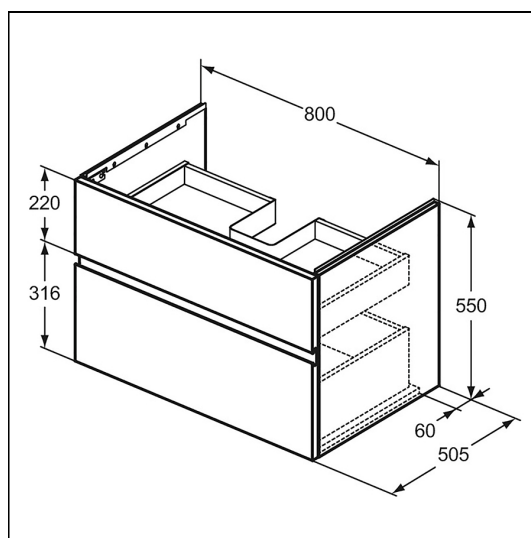

ILLUSTRATED PRODUCT DETAILS





Weights

- E3396** 32.66 KG
- T4362** 24.00 KG
- E0157** 0.16 KG
- EE23033** 0.10 KG
- 9**
- BC799** 0.01 KG

Materials

- E3396** Mixed Material
- T4362** Fine Fireclay
- E0157** Metal
- EE23033** Plastic
- 9**
- BC799** Chrome Plated Brass

Finishes

- E3396**  Matt White (Y1)
- T4362**  White (01)
- E0157**  Neutral / No Finish (67)
- EE23033**  Neutral / No Finish (67)
- 9**
- BC799**  Chrome finish (AA)

FINISH OPTIONS

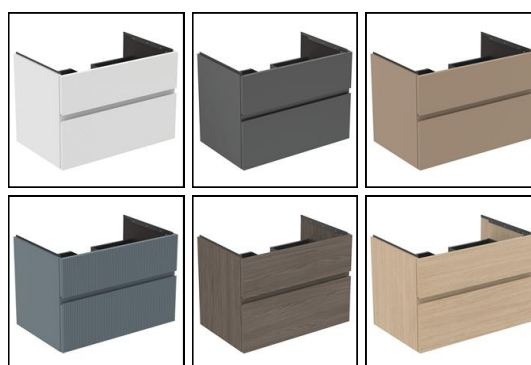
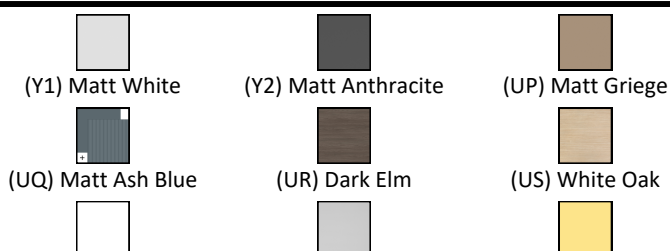

ACCREDITATIONS



Finesse 80cm Wall mounted Vanity Unit

(01) White



(V1) Silk White



(A2) Brushed Gold



(A5) Magnetic Grey

(AA) Chrome finish

(GN) Silver Storm

Standards

EN 14749:2005

Special Notes

Furniture units should be installed in a bathroom with adequate ventilation. Mounting kit included. Always use appropriate fixings to suit the type of wall.