

Finesse 80cm Wall Mounted Washbasin Unit

ILLUSTRATED

- E3423** Finesse 80cm x 44cm wall mounted washbasin unit with 2 drawers, no cutout
- EE230339** Space saving trap and waste pipe assembly for use with furniture basin units

ILLUSTRATED PRODUCT DETAILS

Weights

E3423 33.19 KG

EE23033 0.10 KG

9

Materials

E3423 Mixed Material

EE23033 Plastic

9

Finishes

E3423  Matt White (Y1)

EE23033  Neutral/No Finish (67)

FINISH OPTIONS

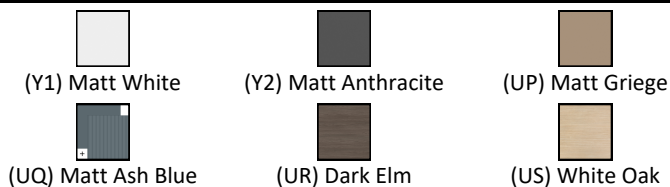

Standards

EN 14749:2005

Special Notes

Furniture units should be installed in a bathroom with adequate ventilation. Mounting kit included. Always use appropriate fixings to suit the type of wall.

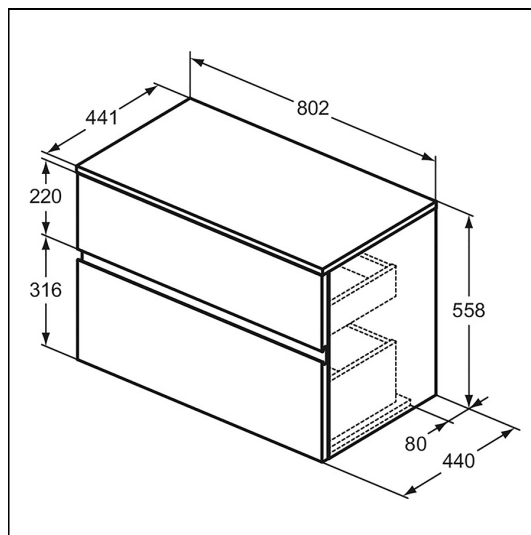

ACCREDITATIONS

