

Finesse 100cm Wall Mounted Washbasin Unit

ILLUSTRATED

- E3424** Finesse 100cm x 44cm wall mounted washbasin unit with 2 drawers, no cutout
- EE23033** Space saving trap and waste pipe assembly for use with furniture basin units

ILLUSTRATED PRODUCT DETAILS

Weights

E3424 38.43 KG

EE23033 0.10 KG

9

Materials

E3424 Mixed Material

EE23033 Plastic







9

Finishes

E3424  Matt White (Y1)

EE23033  Neutral/No Finish (67)

FINISH OPTIONS

		
(Y1) Matt White	(Y2) Matt Anthracite	(UP) Matt Griege
		
(UQ) Matt Ash Blue	(UR) Dark Elm	(US) White Oak

Standards

EN 14749:2005

Special Notes

Furniture units should be installed in a bathroom with adequate ventilation. Mounting kit included. Always use appropriate fixings to suit the type of wall.

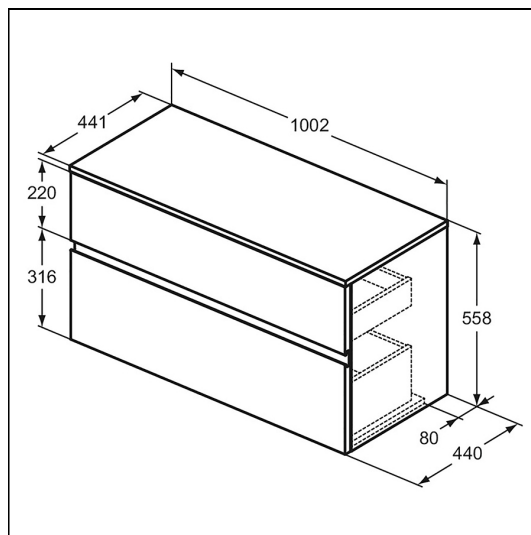

ACCREDITATIONS

