

Finesse 100cm Wall Mounted Washbasin Unit

ILLUSTRATED

- E3435** Finesse 100cm x 50cm wall mounted washbasin unit with 2 drawers, no cutout
- EE23033** Space saving trap and waste pipe assembly for use with furniture basin units

ILLUSTRATED PRODUCT DETAILS

Weights

- E3435** 45.29 KG
- EE23033** 0.10 KG



9

Materials







- E3435** Mixed Material
- EE23033** Plastic

9

Finishes

- E3435**  Matt White (Y1)
- EE23033**  Neutral/No Finish (67)

FINISH OPTIONS

- | | | |
|-----------------------------------------------------------------------------------|-----------------------------------------------------------------------------------|-----------------------------------------------------------------------------------|
|  |  |  |
| (Y1) Matt White | (Y2) Matt Anthracite | (UP) Matt Griege |
|  |  |  |
| (UQ) Matt Ash Blue | (UR) Dark Elm | (US) White Oak |

Standards

EN 14749:2005

Special Notes

Furniture units should be installed in a bathroom with adequate ventilation. Mounting kit included. Always use appropriate fixings to suit the type of wall.

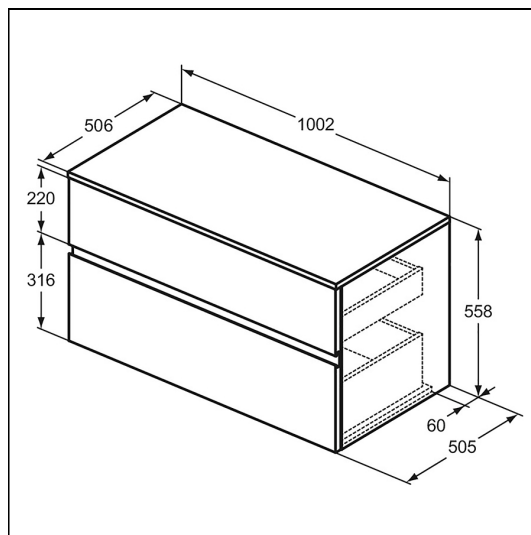

ACCREDITATIONS

