

Concept 170cm x 70cm Idealform Bath No Tapholes

ILLUSTRATED

- E7352** Concept 170cm x 70cm Idealform bath with no tapholes
- E3194** Unilux 170cm front panel
- E3169** Unilux 70cm end panel
- S8970** Trap 1½" plastic P with 75mm seal, multi-purpose outlet suitable for plastic and BS copper pipe
- E1486** Luxury bath pop-up waste and overflow
- A5901** TMV thermostatic mixing valve, 22mm

OPTIONS

- BD264** Ceraplan dual control bath filler

ILLUSTRATED PRODUCT DETAILS







Weights

- E7352** 20.70 KG
- E3194** 3.65 KG
- E3169** 2.58 KG
- S8970** 1.00 KG
- A5901** 0.60 KG

Materials

- E7352** Idealform
- E3194** High Impact Polystyrene
- E3169** High Impact Polystyrene
- S8970** Plastic
- E1486** Mixed Material
- A5901** Chrome Plated Metal

Finishes

- E7352**  White (01)
- E3194**  White (01)
- E3169**  White (01)
- S8970**  Neutral / No Finish (67)
- E1486**  Chrome (AA)
- A5901**  Chrome (AA)

Capacity

- E7352** 174.0 litres (to overflow)

Designer

Robin Levien, RDI

Standards

Constructed to EN 198:2008. EN 14516

Special Notes

Consideration should be given to safe hot water delivery and the use of an appropriate temperature reduction device, see A5901AA or Part G for guidance. One taphole fittings require offsetting from the overflow. Check positioning and compatibility before specifying.

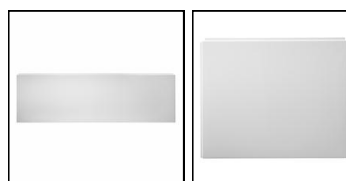
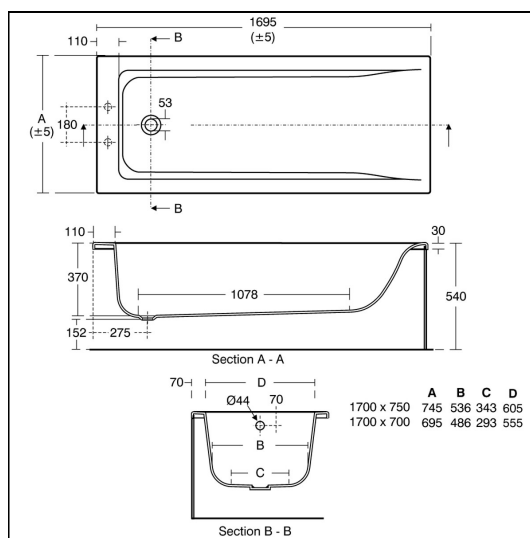

ACCREDITATIONS

E7352(01)



FEATURES

