

# Simplicity Steel Bath 150x70cm 2 Tapholes With Handgrips & Anti-slip\*

## ILLUSTRATED

- E8185** Simplicity 150cm x 70cm standard gauge steel bath with chrome plated grips, two tapholes and anti-slip\*
- B1151** Calista dual control two hole bath filler
- S0915** Bath flat front panel
- S0916** Bath flat end panel
- S9365** Bath panel plastic corner edge strip
- S8970** Trap 1½" plastic P with 75mm seal, multi-purpose outlet suitable for plastic and BS copper pipe
- S8840** 1 1/2" combination bath waste & trap with overflow and domed clicker
- A5901** TMV thermostatic mixing valve, 22mm

## OPTIONS

- B1824** Ceraflex dual control 2 tap hole bath filler
- B1152** Calista dual control two hole bath shower mixer with shower set
- B1823** Ceraflex 2 hole bath shower mixer dual control
- S8830** Waste 1½" bath chain and overflow, plastic plug

## ILLUSTRATED PRODUCT DETAILS









### Weights

- E8185** 24.32 KG
- B1151** 1.60 KG
- S0915** 2.14 KG
- S0916** 3.50 KG
- S9365** 0.01 KG
- S8970** 1.00 KG
- S8840** 0.31 KG
- A5901** 0.60 KG

### Materials

- E8185** Porcelain Enamelled Steel
- B1151** Chrome Plated Brass
- S0915** High Impact Polystyrene
- S0916** High Impact Polystyrene
- S9365** Plastic
- S8970** Plastic
- S8840** Plastic
- A5901** Chrome Plated Metal

### Finishes

- E8185**  White (01)
- B1151**  Chrome (AA)
- S0915**  White (01)
- S0916**  White (01)
- S9365**  White (01)
- S8970**  Neutral/No Finish (67)
- S8840**  Chrome (AA)
- A5901**  Chrome (AA)

### Capacity

- E8185** 139.0 litres (to overflow)

### Flow rates

- B1151** 70 Litres per minute @ 3 bar pressure

### Standards

Manufactured to BS 1344-3:1998  
Standard gauge 2mm porcelain enamelled steel

### Special Notes

\*Anti-slip reduces the likelihood of slipping but it does not prevent all slipping. Care to be taken when cleaning as aggressive products may

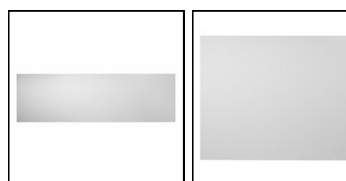
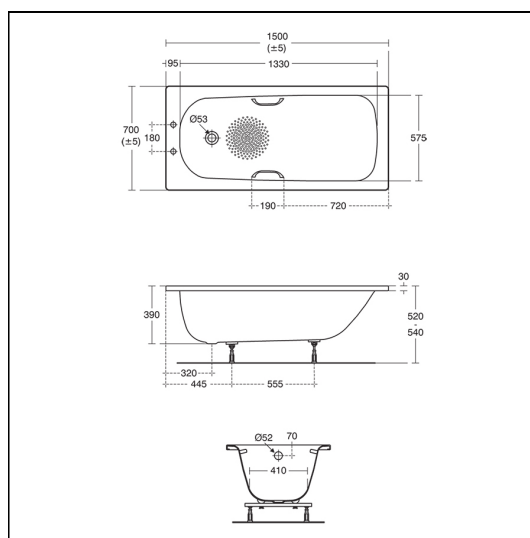

## FEATURES



## Simplicity Steel Bath 150x70cm 2 Tapholes With Handgrips & Anti-slip\*

reduce the effectiveness of the slip resistant area.

Consideration should be given to safe hot water delivery and the use of an appropriate temperature reduction device see A5901AA or Part G for guidance.