

Concept 170cm x 75cm Idealform Plus+ Bath No Tapholes

ILLUSTRATED

- E8602** Concept 170cm x 75cm Idealform Plus+ bath with no tapholes
- E4797** Unilux Plus+ 170cm front panel
- E4832** Unilux Plus+ 75cm end panel
- S8970** Trap 1½" plastic P with 75mm seal, multi-purpose outlet suitable for plastic and BS copper pipe
- E1486** Luxury bath pop-up waste and overflow
- A5901** TMV thermostatic mixing valve, 22mm

OPTIONS

- BD264** Ceraplan dual control bath filler
- S8830** Waste 1½" bath chain and overflow, plastic plug

ILLUSTRATED PRODUCT DETAILS







Weights

- E8602** 28.50 KG
- E4797** 3.65 KG
- E4832** 2.58 KG
- S8970** 1.00 KG
- A5901** 0.60 KG

Materials

- E8602** Idealform Plus+
- E4797** High Impact Polystyrene
- E4832** High Impact Polystyrene
- S8970** Plastic
- E1486** Mixed Material
- A5901** Chrome Plated Metal

Finishes

- E8602**  White (01)
- E4797**  White (01)
- E4832**  White (01)
- S8970**  Neutral/No Finish (67)
- E1486**  Chrome (AA)
- A5901**  Chrome (AA)

Capacity

- E8602** 186.0 litres (to overflow)

Designer

Robin Levien, RDI

Standards

Constructed to EN 198:2008. EN 14516

Special Notes

Consideration should be given to safe hot water delivery and the use of an appropriate temperature reduction device, see A5901AA or Part G for guidance. One taphole fittings require offsetting from the overflow. Check positioning and compatibility before specifying.

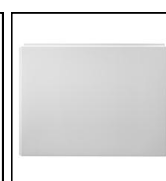
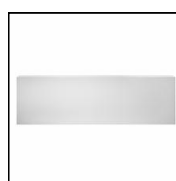
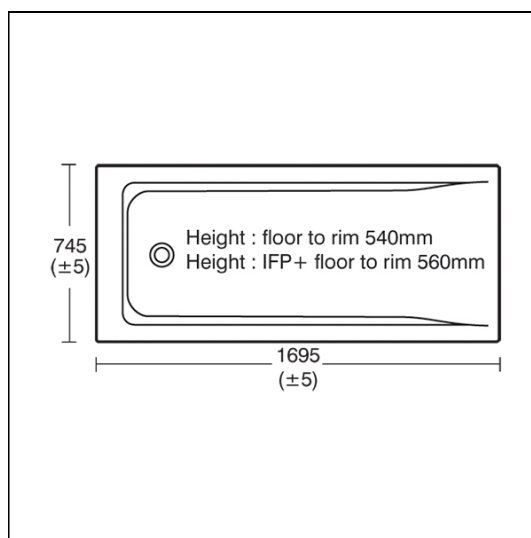

FEATURES

