

Doon Sink 180x60cm Double Bowl, RH Drainer, No Taphole

ILLUSTRATED

- S1279** (ST C) Doon sink, double bowl right hand drainer 180 x 60cm, no tapholes, no overflow
- S8270** (TB H1) Markwik ½" lever action bib taps
- B1686** Nimbus 21 concealed bib tap wall mount with self centralising installation (pair)
- B1682** Nimbus 21 1/2" x 75mm bib tap extensions (pair)
- S8760** Waste 1½" unslotted strainer waste, 50mm long, 75mm dia. brass
- S8925** (TRR2/P) Trap 1½" plastic resealing bottle with 75mm seal, multi-purpose outlet

OPTIONS

- S9281** Leg 900mm stainless steel to floor (2 required)
- S8768** (WT4) Waste 1½" unslotted chain waste, plug and screw stay, 90mm tail

ILLUSTRATED PRODUCT DETAILS







Weights

- S1279** 11.00 KG
- S8270** 1.65 KG
- S8760** 0.23 KG
- S8925** 0.33 KG

Materials

- S1279** Stainless Steel
- S8270** Chrome Plated Brass
- B1686** Chrome Plated Brass
- B1682** Chrome Plated Brass
- S8760** Chrome Plated Metal
- S8925** Plastic

Finishes

- S1279**  Stainless Steel finish (MY)
- S8270**  Chrome (AA)
- B1686**  Chrome (AA)
- B1682**  Chrome (AA)
- S8760**  Chrome (AA)
- S8925**  Neutral / No Finish (67)

Standards

NHS specification HBN 00-10. EN 13310

Special Notes

HTM64 does not cover for legs to floor.

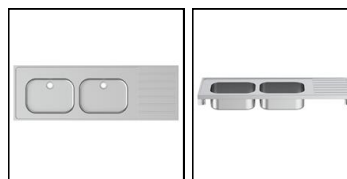
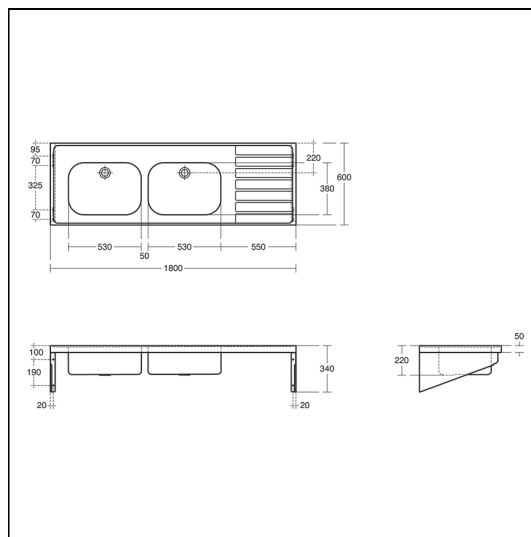

FEATURES

