

# Leven Ti Slophopper

## ILLUSTRATED

- S1291** Leven top inlet stainless steel slophopper
- B1684** Nimbus 21 1/2" x 100mm bib tap extensions (pair)
- S4662** Plastic Flushpipe For Top Inlet Slop Hopper
- S1164** Regal high level plastic 6 litre cistern, single flush syphon, side supply, internal overflow, metal chain pull with 4 piece plastic flushpipe (fittings are reversible)
- S3584** P trap outlet, plastic for slop hoppers
- S8270** (TB H1) Markwik 1/2" lever action bib taps
- B1686** Nimbus 21 concealed bib tap wall mount with self centralising installation (pair)

## OPTIONS

- S9281** Leg 900mm stainless steel to floor (2 required)
- B1688** Nimbus 21 exposed bib tap wall mount with self centralising installation (pair)

## ILLUSTRATED PRODUCT DETAILS







### Weights

- S1291** 12.50 KG
- S4662** 0.10 KG
- S1164** 3.40 KG
- S3584** 0.26 KG
- S8270** 1.65 KG

### Materials

- S1291** Stainless Steel
- B1684** Chrome Plated Brass
- S4662** Plastic
- S1164** Plastic
- S3584** Plastic
- S8270** Chrome Plated Brass
- B1686** Chrome Plated Brass

### Finishes

- S1291**  Stainless Steel finish (MY)
- B1684**  Chrome (AA)
- S4662**  White (01)
- S1164**  White (01)
- S3584**  White (01)
- S8270**  Chrome (AA)
- B1686**  Chrome (AA)

### Capacity

- S1164** 6.0 litres

### Standards

Manufactured from 1.2mm 1.4301 (304) Stainless Steel sheet, conforms to BS EN 10088: Part 2: 2005. EN 13310.

### Special Notes

For the disposal of liquid and solid waste in connection with clinical procedures. HTM64 does not cover for the provision of leg supports to floor. Note 2.94 states that "Exposed services are visually unattractive, can be unhygienic and are difficult to clean and decorate. Indeed the additional cost of the latter over a number of years may well exceed any savings in initial capital costs"

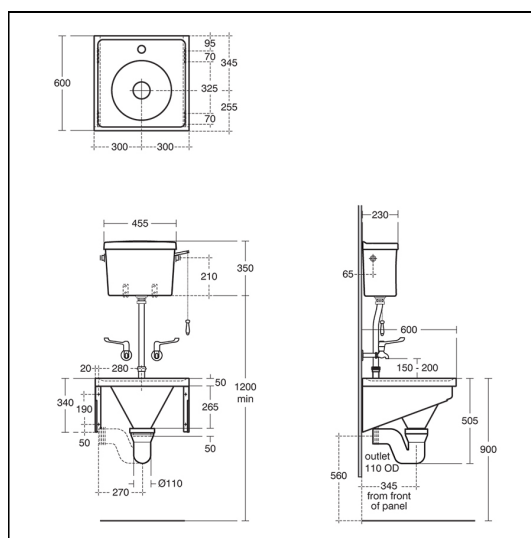

## FEATURES

