

Sandringham 21 Steel bath 170cmx70cm 2 Tapholes With Handgrips & Anti-slip*

ILLUSTRATED

- S1835** Sandringham 21 170cm x 70cm standard gauge steel bath with chrome plated grips, two tapholes and anti-slip*
- B3309** Sandringham SL 21 2 hole bath filler
- S8970** Trap 1½" plastic P with 75mm seal, multi-purpose outlet suitable for plastic and BS copper pipe
- S8840** 1 1/2" combination bath waste & trap with overflow and domed clicker
- A5901** TMV thermostatic mixing valve, 22mm

OPTIONS

- S0915** Bath flat front panel
- S0916** Bath flat end panel
- S9365** Bath panel plastic corner edge strip

ILLUSTRATED PRODUCT DETAILS





Weights

- S1835** 27.01 KG
- B3309** 1.68 KG
- S8970** 1.00 KG
- S8840** 0.31 KG
- A5901** 0.60 KG

Materials

- S1835** Porcelain Enamelled Steel
- B3309** Chrome Plated Brass
- S8970** Plastic
- S8840** Plastic
- A5901** Chrome Plated Metal

Finishes

- S1835**  White (01)
- B3309**  Chrome (AA)
- S8970**  Neutral / No Finish (67)
- S8840**  Chrome (AA)
- A5901**  Chrome (AA)

Capacity

- S1835** 160.0 litres (to overflow)

Flow rates

- B3309** 70 Litres per minute @ 3 bar pressure

Standards

BS 1390:1990. EN 14516

Special Notes

*Anti slip is a resistant finish that reduces the chances of slipping, it does not prevent all slipping. Not suitable in areas involving the use of special chemicals. Framework is required at installation to support rim and secure panel. Panels require trimming to size at installation. Consideration should be given to safe hot water delivery and the use of an appropriate temperature reduction device, see A5901AA or Part G for guidance.

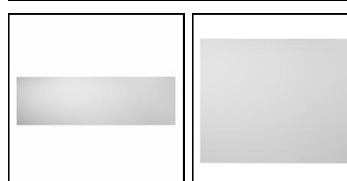
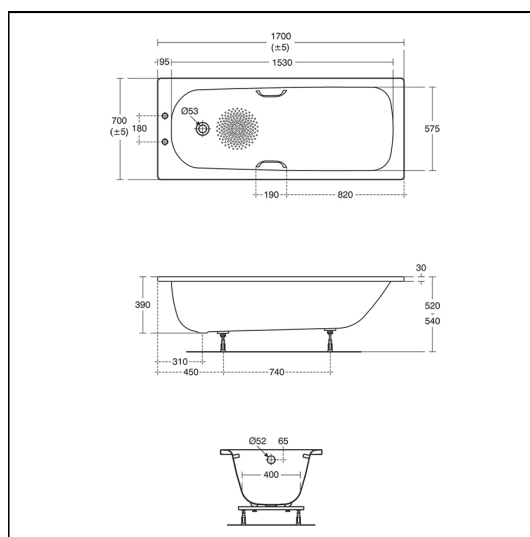

ACCREDITATIONS

S1835(01)

Unified Water Label  160.0 Litres

B3309(AA)

Unified Water Label  70.00 Litres Per Minute