

# Dee Bi Sink & RH Slophopper, No Taphole

## ILLUSTRATED

- S3335** (DU HS) Dee right hand slop hopper with sink, back inlet
- S4663** Flushpipe 850 x 35mm diameter for slop hopper
- B1684** Nimbus 21 1/2" x 100mm bib tap extensions (pair)
- S3626** Conceala 2 high level 6 litre cistern, single flush syphon, side supply, internal overflow, lever with chain
- S3584** P trap outlet, plastic for slop hoppers
- S8925** (TRR2/P) Trap 1 1/2" plastic resealing bottle with 75mm seal, multi-purpose outlet
- S8760** Waste 1 1/2" unslotted strainer waste, 50mm long, 75mm dia. brass
- S8270** (TB H1) Markwik 1/2" lever action bib taps
- B1686** Nimbus 21 concealed bib tap wall mount with self centralising installation (pair)

## OPTIONS

- S4385** High Level Lever Assembly For Conceala 1 Cistern
- S9281** Leg 900mm stainless steel to floor (2 required)
- S3632** Conceala 1 cistern 9 litre single flush syphon, alternative height plastic flushbends side supply and internal overflow, no lever

## ILLUSTRATED PRODUCT DETAILS









### Weights

- S3335** 20.00 KG
- S4663** 2.00 KG
- S3626** 3.00 KG
- S3584** 0.26 KG
- S8925** 0.33 KG
- S8760** 0.23 KG
- S8270** 1.65 KG

### Materials

- S3335** Stainless Steel
- S4663** Plastic
- B1684** Chrome Plated Brass
- S3626** Plastic
- S3584** Plastic
- S8925** Plastic
- S8760** Chrome Plated Metal
- S8270** Chrome Plated Brass
- B1686** Chrome Plated Brass

### Finishes

- S3335**  Stainless Steel finish (MY)
- S4663**  Neutral / No Finish (67)
- B1684**  Chrome (AA)
- S3626**  Neutral / No Finish (67)
- S3584**  White (01)
- S8925**  Neutral / No Finish (67)
- S8760**  Chrome (AA)
- S8270**  Chrome (AA)
- B1686**  Chrome (AA)

### Capacity

- S3626** 6.0 litres

### Standards

1.2mm Stainless steel sheet conforms to BS EN 10088:Part 2:2005. Other items to relevant standards. NHS specification HBN 00-10. EN 13310.

### Special Notes

Note HTM64 does not cover for the provision of leg supports to floor.

E: [info@idealspec.co.uk](mailto:info@idealspec.co.uk) | T: 0870 122 8822 | F: 0870 122 8282 | [www.idealspec.co.uk](http://www.idealspec.co.uk)

Ideal Standard (UK) Ltd. makes every effort to ensure that the information provided on its website is accurate. However, we cannot guarantee this, and accept no liability for any information or advice given via its website.

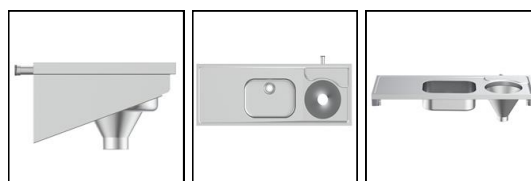
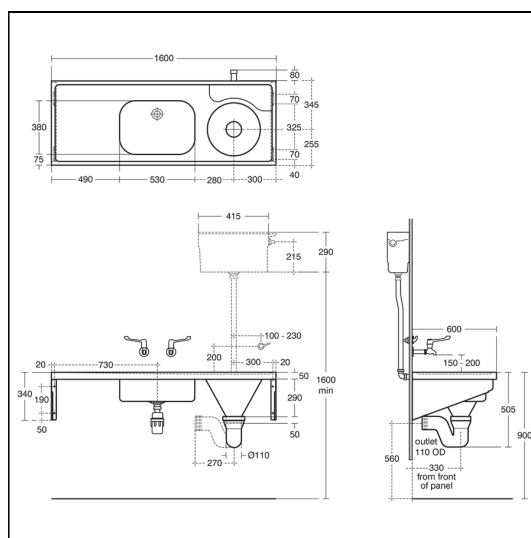

## FEATURES

