

# Doc M Sandringham Bowl Urinal

## ILLUSTRATED

- S6103** Sandringham wall bowl urinal
- S6454** Contour 21 grab rail straight 60cm long x 35mm diameter
- S1155** Conceala 4.5 litre auto cistern with cover, auto syphon and petcock
- S8770** Waste 1½" strainer waste brass with stainless steel dome
- S8915** Trap 1½" plastic bottle with 75mm seal, multi-purpose outlet
- S6226** Flushpipes concealed for 1 bowl urinal
- S6265** Spreader, back inlet Sandringham

## ILLUSTRATED PRODUCT DETAILS







### Weights

- S6103** 7.50 KG
- S6454** 2.00 KG
- S1155** 3.00 KG
- S8770** 0.16 KG
- S8915** 0.24 KG
- S6226** 0.41 KG
- S6265** 0.36 KG

### Materials

- S6103** Vitreous China
- S6454** Aluminium
- S1155** Plastic
- S8770** Chrome Plated Metal
- S8915** Plastic
- S6226** Plastic
- S6265** Chrome Plated Metal







### Finishes

- S6103**  White (01)
- S6454**  White (AC)
- S1155**  Neutral / No Finish (67)
- S8770**  Stainless Steel finish (MY)
- S8915**  Neutral / No Finish (67)
- S6226**  Unfinished (NU)
- S6265**  Chrome (AA)

### Capacity

- S1155** 4.5 litres

## FINISH OPTIONS

- |   |   |   |
|---|---|---|
|  |  |  |
| (36) Blue   | (AC) White  | (L) Grey  |
|  |  |  |
| (MY) Stainless Steel finish   | (RN) Charcoal   | (GQ) Red  |

### Standards

Layout conforms to BS8300:2001 and Document M Overflow the Building Regulations.

### Special Notes

Wheelchair users may be able to pull themselves to a standing position to use a urinal, or they may be able to use a urinal from their wheelchair. The lower urinal position shown is also beneficial to a person of lower stature. Must be used in wheelchair accessible male washrooms. Minimum of 2 x 600mm S6454 grab rails. Urinal secured to wall with wall fixing screws (not supplied)  
 White:Ral=9016, LRV=87  
 Blue:Ral=5011, LRV=6  
 Red:Ral=3020, LRV=12  
 Grey:Ral=7005, LRV=19

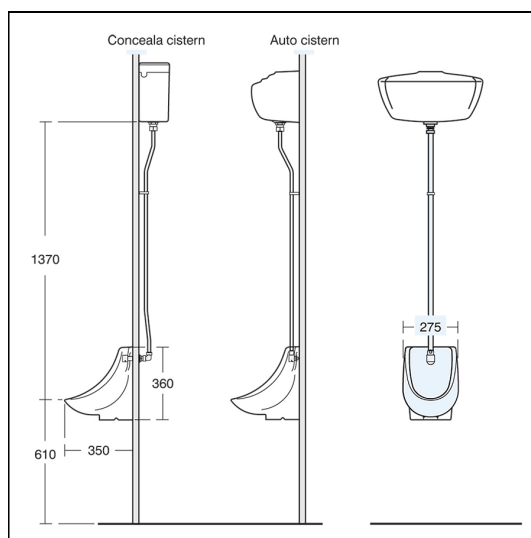

## FEATURES



## Doc M Sandringham Bowl Urinal

Charcoal:Ral=7016, LRV=8