

Concept Freedom Ensuite Bathroom Pack with 40cm Basin & Extended Wall Hung WC - Individual Items

ILLUSTRATED

- S6404** Concept Freedom ensuite bathroom pack with 40cm basin & extended wall hung WC
- E8197** Concept Freedom wall hung rimless toilet bowl with horizontal outlet, 75cm projection
- S9139** Support bracket for wall mounted WC raised height with bolts
- E8226** Concept Freedom seat no cover for elongated pan
- S6362** Contemporary 21 hinged support rail, 80cm Doc M Compliant
- S6637** Multi-System back support, white, complete with cushion
- E8031** Concept Cube 40cm handrinse washbasin, 1 taphole with overflow
- A5900** TMV thermostatic mixing valve, 15mm
- E0079** Trap 1½" Contemporary metal bottle, 75mm seal
- S3636** Conceala 2 delay fill 4.5/3 or 4/2.6 litre cistern, dual flush valve, bottom supply, internal overflow, alternative height plastic flushbends, no flushplate
- S4302** Contour 21 flushpipe constructed, necessary for installation
- E0157** Wall fixing set
- S0830** Contour 21 60cm contemporary grab rail
- S0831** Contour 21 45cm contemporary grab rail
- BC186** Ceraline single lever basin mixer including clicker waste

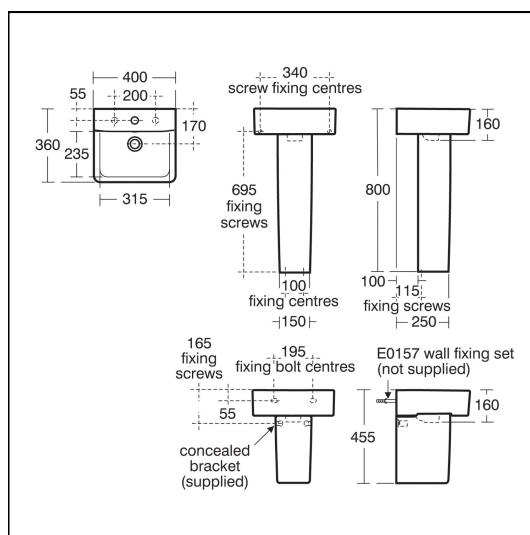
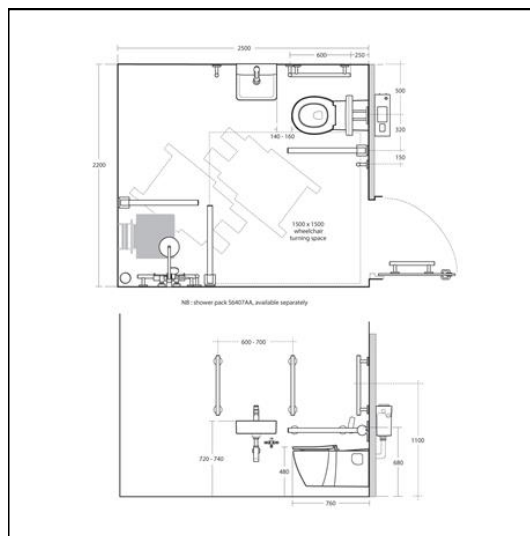

ILLUSTRATED PRODUCT DETAILS

Sizes

E8031 w:400 x d:360













Weights

- E8197** 33.00 KG
- S9139** 4.28 KG
- E8226** 1.40 KG
- S6362** 3.00 KG
- S6637** 3.63 KG
- E8031** 10.08 KG
- A5900** 0.50 KG
- E0079** 1.45 KG
- S3636** 3.00 KG
- S4302** 0.39 KG
- E0157** 0.16 KG
- S0830** 4.26 KG
- S0831** 3.20 KG
- BC186** 1.39 KG

Materials

- S6404** Chrome Plated Metal & Vitreous China
- E8197** Vitreous China
- S9139** Metal
- E8226** Plastic
- S6362** Aluminium
- S6637** Mixed Material
- E8031** Fine Fireclay
- A5900** Chrome Plated Metal

Finishes

- S6404**  Chrome (AA)
- E8197**  White (01)
- S9139**  Neutral / No Finish (67)
- E8226**  White (01)
- S6362**  Chrome finish (AA)
- S6637**  White (AC)
- E8031**  White (01)
- A5900**  Chrome (AA)
- E0079**  Chrome (AA)
- S3636**  Neutral / No Finish (67)
- S4302**  Neutral / No Finish (67)
- E0157**  Neutral / No Finish (67)





FEATURES



E: info@idealspec.co.uk | T: 0870 122 8822 | F: 0870 122 8282 | www.idealspec.co.uk

Ideal Standard (UK) Ltd. makes every effort to ensure that the information provided on its website is accurate. However, we cannot guarantee this, and accept no liability for any information or advice given via its website.

Concept Freedom Ensuite Bathroom Pack with 40cm Basin & Extended Wall Hung WC - Individual Items

E0079	Chrome Plated Metal	S0830		Chrome (AA)
S3636	Plastic	S0831		Chrome (AA)
S4302	Plastic	BC186		Chrome (AA)
E0157	Metal			
S0830	Aluminium			
S0831	Aluminium			
BC186	Chrome Plated Brass			

Capacity

E8031	2.1 litres
S3636	4.5 litres







Flow rates

BC186	5 Litres per minute @ 3 bar pressure
--------------	--------------------------------------

Designer

Robin Levien, RDI

FINISH OPTIONS

		
(01) White	(V3) Silk Black	(AA) Chrome finish
		
(MY) Stainless Steel finish	(XG) Silk Black	(AA) Chrome

Special Notes

Supplied with layout drawings, detailing the fixing postions necessary for DOC M compliance