

Leven Back Inlet Slophopper In Stainless Steel

ILLUSTRATED

- S6567** (DU) Leven slop hopper stainless steel, back inlet
- S4663** Flushpipe 850 x 35mm diameter for slop hopper
- B1684** Nimbus 21 1/2" x 100mm bib tap extensions (pair)
- S3626** Conceala 2 high level 6 litre cistern, single flush syphon, side supply, internal overflow, lever with chain
- S3584** P trap outlet, plastic for slop hoppers
- S8270** (TB H1) Markwik 1/2" lever action bib taps
- B1686** Nimbus 21 concealed bib tap wall mount with self centralising installation (pair)

OPTIONS

- S4385** High Level Lever Assembly For Conceala 1 Cistern
- S9281** Leg 900mm stainless steel to floor (2 required)
- S3632** Conceala 1 cistern 9 litre single flush syphon, alternative height plastic flushbends side supply and internal overflow, no lever

ILLUSTRATED PRODUCT DETAILS







Weights

- S6567** 12.50 KG
- S4663** 2.00 KG
- S3626** 3.00 KG
- S3584** 0.26 KG
- S8270** 1.65 KG

Materials

- S6567** Stainless Steel
- S4663** Plastic
- B1684** Chrome Plated Brass
- S3626** Plastic
- S3584** Plastic
- S8270** Chrome Plated Brass
- B1686** Chrome Plated Brass

Finishes

- S6567**  Stainless Steel (MY)
- S4663**  Neutral/No Finish (67)
- B1684**  Chrome (AA)
- S3626**  Neutral/No Finish (67)
- S3584**  White (01)
- S8270**  Chrome (AA)
- B1686**  Chrome (AA)

Capacity

- S3626** 6.0 litres

Standards

Manufactured from 1.2mm 1.4301 (304) Stainless Steel sheet, conforms to BS EN 10088: Part 2: 2005

Special Notes

HTM64 does not cover for the provision of leg supports to floor

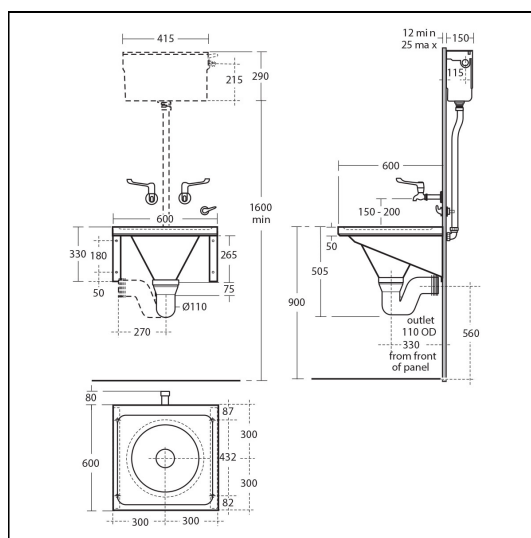

FEATURES

