

Tesi 170cm x 70cm Bath

ILLUSTRATED

- T0005** Tesi 170cm x 70cm Idealform bath, no tapholes
- A6590** Tesi 2 hole dual control bath filler
- E3194** Unilux 170cm front panel
- E3169** Unilux 70cm end panel
- E1486** Luxury bath pop-up waste and overflow
- A5901** TMV thermostatic mixing valve, 22mm

ILLUSTRATED PRODUCT DETAILS







Weights

- T0005** 21.00 KG
- A6590** 2.33 KG
- E3194** 3.65 KG
- E3169** 2.58 KG
- A5901** 1.70 KG

Materials

- T0005** Idealform
- A6590** Chrome Plated Metal
- E3194** Acrylic
- E3169** Acrylic
- E1486** Mixed Material
- A5901** Chrome Plated Metal

Finishes

- T0005**  White (01)
- A6590**  Chrome (AA)
- E3194**  White (01)
- E3169**  White (01)
- E1486**  Chrome (AA)
- A5901**  Chrome (AA)

Capacity

- T0005** 173.0 litres (to overflow)

Designer

Artefakt Industriekultur

Standards

Contracted to EN 198:2008. EN 14516

Special Notes

Consideration should be given to safe hot water delivery and the use of an appropriate temperature reduction device, see A5901AA or Part G for guidance. One taphole fittings require offsetting from the overflow. Check positioning and compatibility before specifying.

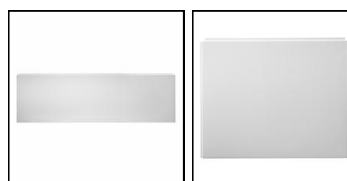
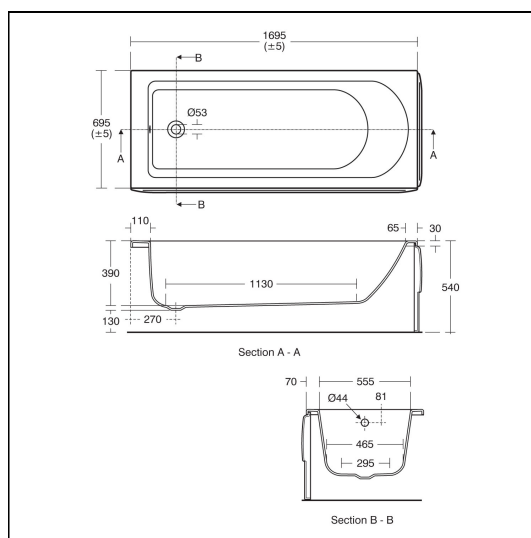

FEATURES

