

# Tesi 45cm Handrinse Corner Basin

## ILLUSTRATED

- T3525** Tesi 45cm handrinse corner basin, 1 taphole with overflow
- T3521** Tesi handrinse pedestal
- E0157** Wall fixing set
- BC722** Cerafine O single lever mini basin mixer
- E1482** 1 1/4" basin clicker waste: slotted
- S8910** Trap 1 1/4" plastic bottle, 75mm seal, multi-purpose outlet

## OPTIONS

- E0079** Trap 1 1/4" Contemporary metal bottle, 75mm seal

## ILLUSTRATED PRODUCT DETAILS

### Sizes

**T3525** w:545 x d:465







### Weights

- T3525** 23.90 KG
- T3521** 7.50 KG
- E0157** 0.16 KG
- BC722** 1.33 KG
- S8910** 0.20 KG

### Materials

- T3525** Fine Fireclay
- T3521** Vitreous China
- E0157** Metal
- BC722** Chrome Plated Brass
- E1482** Chrome Plated Metal
- S8910** Plastic

### Finishes

- T3525**  White (01)
- T3521**  White (01)
- E0157**  Neutral / No Finish (67)
- BC722**  Chrome (AA)
- E1482**  Chrome (AA)
- S8910**  Neutral / No Finish (67)





### Flow rates

**BC722** 5 Litres per minute @ 3 bar pressure

### Designer

Robin Levien, RDI

## FINISH OPTIONS

-   
(AA) Chrome
-   
(XG) Silk Black
-   
(A2) Brushed Gold
-   
(A5) Magnetic Grey
-   
(GN) Silver Storm

### Standards

Washbasin to BS EN 14688 and BS EN 36

### Special Notes

Washbasin wall mounted using E0157 wall fixing set. When fitted to furniture washbasin must be secured to wall with the E0157 wall fixing set.

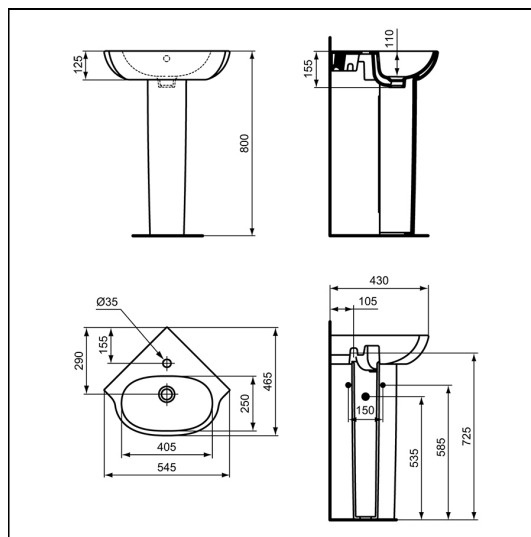

## FEATURES

