

Conca 80cm x 50cm Wall Hung Vanity Unit

ILLUSTRATED

- T4574** Conca 80cm x 50cm wall hung vanity unit with 2 drawers
- T4362** Extra 80cm vanity washbasin, 1 taphole with overflow
- E0157** Wall fixing set
- BC799** Joy single lever basin mixer with click waste
- EE230339** Space saving trap and waste pipe assembly for use with furniture basin units

OPTIONS

- T4364** Extra 80cm vanity washbasin, 3 tapholes with overflow
- T4365** Extra 80cm vanity washbasin, no taphole with overflow

ILLUSTRATED PRODUCT DETAILS





Weights

- T4574** 30.00 KG
- T4362** 24.00 KG
- E0157** 0.16 KG
- BC799** 0.01 KG
- EE230339** 0.10 KG

Materials

- T4574** Mixed Material
- T4362** Fine Fireclay
- E0157** Metal
- BC799** Chrome Plated Brass
- EE230339** Plastic

Finishes

- T4574**  Matt White (Y1)
- T4362**  White (01)
- E0157**  Neutral/No Finish (67)
- BC799**  Chrome finish (AA)
- EE230339**  Neutral/No Finish (67)

Capacity







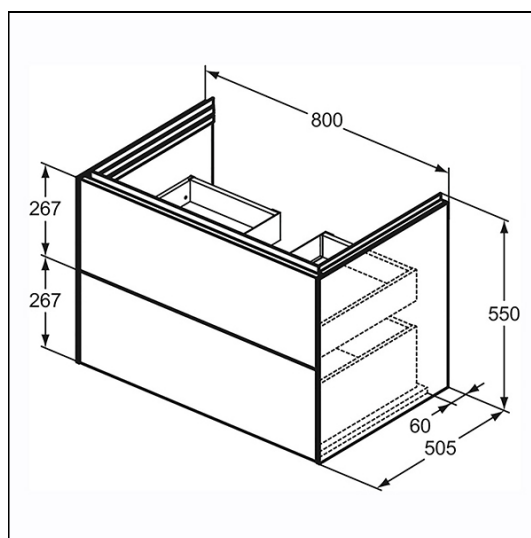





- T4362** 10.6 litres

Designer

Palomba Serafini Associati



FINISH OPTIONS

- | | | |
|---|---|---|
|  |  |  |
| (Y1) Matt White | (Y2) Matt Anthracite | (Y3) Matt Sunset |
|  |  |  |
| (Y4) Smoked Oak | (Y5) Dark Walnut | (Y6) Light Oak |
|  |  |  |
| (01) White | (V1) Silk White | (A2) Brushed Gold |
|  |  |  |
| (A5) Magnetic Grey | (AA) Chrome finish | (GN) Silver Storm |



ACCREDITATIONS



Standards

EN 14749:2005

Special Notes

Furniture units should be installed in a bathroom with adequate ventilation. Mounting kit included. Always use appropriate fixings to suit the type of wall. Space saving trap to be ordered separately using code EE23033967.

E: info@idealspec.co.uk | T: 0870 122 8822 | F: 0870 122 8282 | www.idealspec.co.uk

Ideal Standard (UK) Ltd. makes every effort to ensure that the information provided on its website is accurate. However, we cannot guarantee this, and accept no liability for any information or advice given via its website.

