

i.life 170cm x 70cm Rectangular Idealform+ Bath

ILLUSTRATED

T4797	i.life 170cm x 70cm rectangular idealform+ bath with no taphole
T4828	i.life Fixation Set
BD264	Ceraplan dual control bath filler
E4797	Unilux Plus+ 170cm front panel
E4831	Unilux Plus+ 70cm end panel
S8970	Trap 1½" plastic P with 75mm seal, multi-purpose outlet suitable for plastic and BS copper pipe
E1486	Luxury bath pop-up waste and overflow
A5901	TMV thermostatic mixing valve, 22mm

ILLUSTRATED PRODUCT DETAILS









Weights

BD264	2.39 KG
E4797	3.65 KG
E4831	2.58 KG
S8970	1.00 KG
A5901	0.60 KG

Materials

T4797	Acrylic
T4828	Acrylic
BD264	Chrome Plated Brass
E4797	High Impact Polystyrene
E4831	High Impact Polystyrene
S8970	Plastic
E1486	Mixed Material
A5901	Chrome Plated Metal

Finishes

T4797		White (01)
T4828		White (01)
BD264		Chrome (AA)
E4797		White (01)
E4831		White (01)
S8970		Neutral / No Finish (67)
E1486		Chrome (AA)
A5901		Chrome (AA)

Capacity

T4797 176.0 litres (to overflow)

Designer

Palomba Serafini Associati

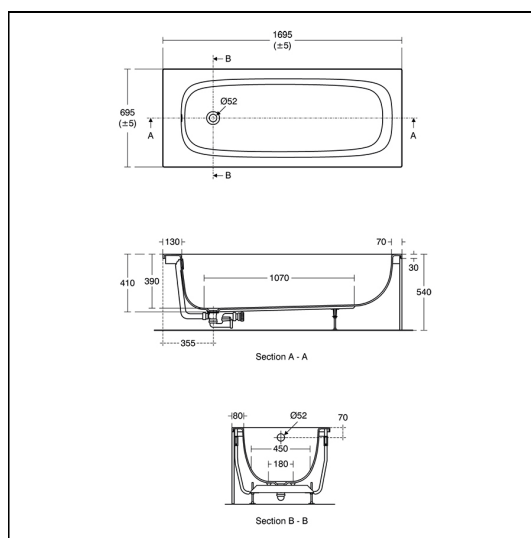

FINISH OPTIONS



Standards

EN 198:2008. EN 14516