

i.life S 40cm Compact Half Column Unit

ILLUSTRATED

T5289 i.life 40cm compact half column unit with 1 door

OPTIONS

T5326 i.life 34cm handle

ILLUSTRATED PRODUCT DETAILS

Materials

T5289 Mixed Material







Finishes

T5289  Matt White (DU)

Designer

Palomba Serafini Associati

FINISH OPTIONS

- | | | |
|---|---|---|
|  |  |  |
| (DU) Matt White | (NF) Matt Sandy Beige | (NG) Matt Quartz Grey |
|  |  |  |
| (NH) Matt Griega | (NV) Matt Carbon Grey | (NW) Coffee Oak |
|  | | |
| (NX) Natural Oak | | |

Standards

EN 14749:2005

Special Notes

Furniture units should be installed in a bathroom with adequate ventilation. Mounting kit included. Always use appropriate fixings to suit the type of wall. Separate handles required

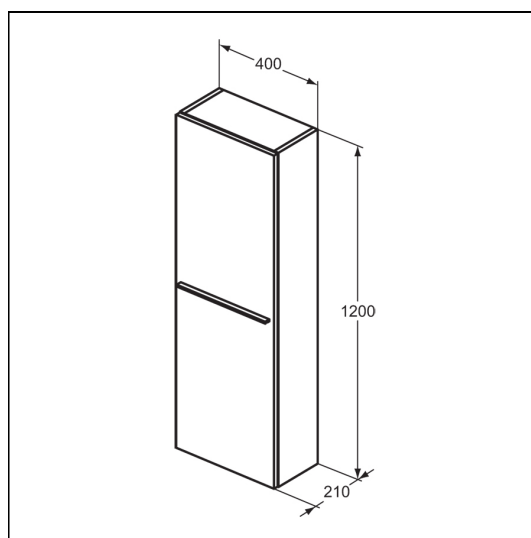

FEATURES

