

i.life 170cm x 75cm Double-Ended Idealform Water Saving Bath

ILLUSTRATED

T5316	i.life 170cm x 75cm double-ended idealform water saving bath with no tapholes
BD264	Ceraplan dual control bath filler
E3194	Unilux 170cm front panel
E3195	Unilux 75cm end panel
S8970	Trap 1½" plastic P with 75mm seal, multi-purpose outlet suitable for plastic and BS copper pipe
E1486	Luxury bath pop-up waste and overflow
A5901	TMV thermostatic mixing valve, 22mm

OPTIONS

T4828	i.life Fixation Set
--------------	---------------------



ILLUSTRATED PRODUCT DETAILS







Weights

T5316	20.00 KG
BD264	2.39 KG
E3194	3.65 KG
E3195	2.58 KG
S8970	1.00 KG
A5901	0.60 KG

Materials

T5316	Acrylic
BD264	Chrome Plated Brass
E3194	High Impact Polystyrene
E3195	High Impact Polystyrene
S8970	Plastic
E1486	Mixed Material
A5901	Chrome Plated Metal

Finishes

T5316	 White (01)
BD264	 Chrome (AA)
E3194	 White (01)
E3195	 White (01)
S8970	 Neutral / No Finish (67)
E1486	 Chrome (AA)
A5901	 Chrome (AA)

Capacity

T5316	139.0 litres (to overflow)
--------------	----------------------------

Designer

Palomba Serafini Associati

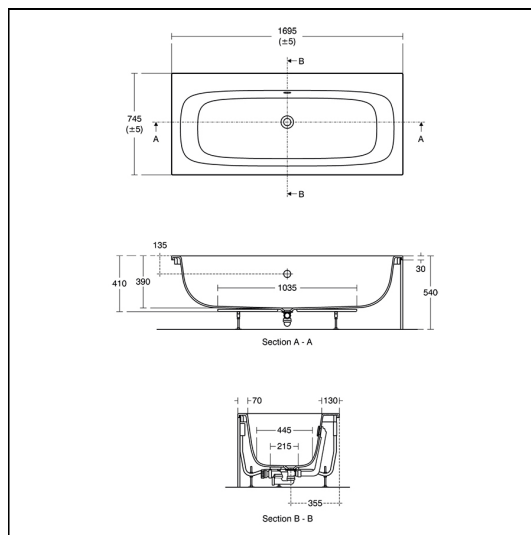

FEATURES



FINISH OPTIONS



Standards

EN 198:2008. EN 14516