

i.life B 120cm x 50cm Wall Mounted Vanity Unit

ILLUSTRATED

- T5586** i.life B 120cm x 50cm wall mounted vanity unit with 2 drawers, left-hand
- E2632** La Dolce Vita 126cm 1 taphole asymmetrical washbasin with overflow, left-hand
- E0157** Wall fixing set
- BD683** La Dolce Vita single lever basin mixer with 118mm spout projection and clicker waste
- EE230339** Space saving trap and waste pipe assembly for use with furniture basin units
- T5742** i.life 34cm handle

ILLUSTRATED PRODUCT DETAILS

Sizes

E2632 w:1260 x d:535







Weights

- T5586** 41.50 KG
- E2632** 36.50 KG
- E0157** 0.16 KG
- BD683** 1.54 KG
- EE230339** 0.10 KG

Materials

- T5586** Mixed Material
- E2632** Fine Fireclay
- E0157** Metal
- BD683** Chrome Plated Brass
- EE230339** Plastic

Finishes

- T5586**  Matt White (DU)
- E2632**  White (01)
- E0157**  Neutral/No Finish (67)
- BD683**  Chrome (AA)
- EE230339**  Neutral/No Finish (67)
- T5742**  Chrome (AA)













Capacity

E2632 7.2 litres

Flow rates

BD683 5 Litres per minute @ 3 bar pressure

FINISH OPTIONS

- | | | |
|---|---|---|
|  |  |  |
| (DU) Matt White | (NF) Matt Sandy Beige | (NG) Matt Quartz Grey |
|  |  |  |
| (NH) Matt Griège | (NV) Matt Carbon Grey | (NW) Coffee Oak |
|  |  |  |
| (NX) Natural Oak | (AA) Chrome | (A2) Brushed Gold |
|  |  |  |
| (A5) Magnetic Grey | (GN) Silver Storm | (XG) Silk Black |

Standards

EN 14749:2005

Special Notes

Furniture units should be installed in a bathroom with adequate ventilation. Mounting kit included. Always use appropriate fixings to suit the type of wall.

E: info@idealspec.co.uk | T: 0870 122 8822 | F: 0870 122 8282 | www.idealspec.co.uk

Ideal Standard (UK) Ltd. makes every effort to ensure that the information provided on its website is accurate. However, we cannot guarantee this, and accept no liability for any information or advice given via its website.

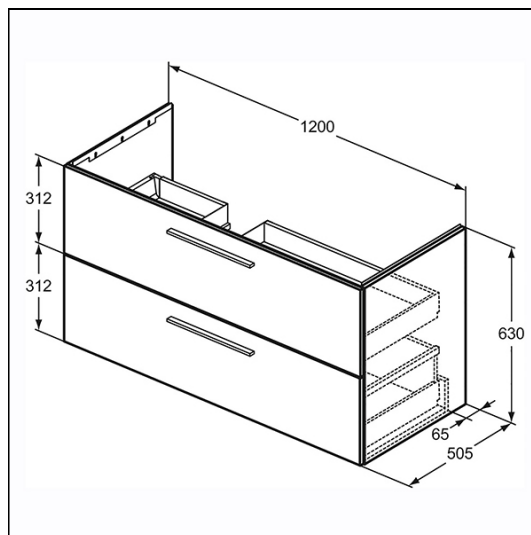

ACCREDITATIONS

