

i.life S 1 Drawer Basin Unit

ILLUSTRATED

- T6848** i.life S 1 drawer basin unit
- T5719** i.life B 45cm 1 taphole handrinse basin
- E0157** Wall fixing set
- EE230339** Space saving trap and waste pipe assembly for use with furniture basin units
- T5742** i.life 34cm handle

OPTIONS

- BD246** Ceraplan single lever basin mixer, with click waste

ILLUSTRATED PRODUCT DETAILS

Sizes

T5719 w:450 x d:375

Weights

T6848 12.59 KG

T5719 11.40 KG

E0157 0.16 KG

EE23033 0.10 KG

9

Materials

T6848 MFC

T5719 Fine Fireclay

E0157 Metal

EE23033 Plastic

9

T5742 Mixed Material

Finishes

T6848  Matt White (DU)









T5719  White (01)

E0157  Neutral/No Finish (67)

EE23033  Neutral/No Finish (67)

T5742  Chrome (AA)

FINISH OPTIONS

- | | | |
|---|---|---|
|  |  |  |
| (DU) Matt White | (NF) Matt Sandy Beige | (NH) Matt Griege |
|  |  |  |
| (NG) Matt Quartz Grey | (NV) Matt Carbon Grey | (NX) Natural Oak |
|  |  |  |
| (NW) Coffee Oak | (AA) Chrome | (XG) Silk Black |

Standards

EN 14749:2005

Special Notes

Furniture units should be installed in a bathroom with adequate ventilation. Mounting kit included. Always use appropriate fixings to suit the type of wall. Separate handles required.

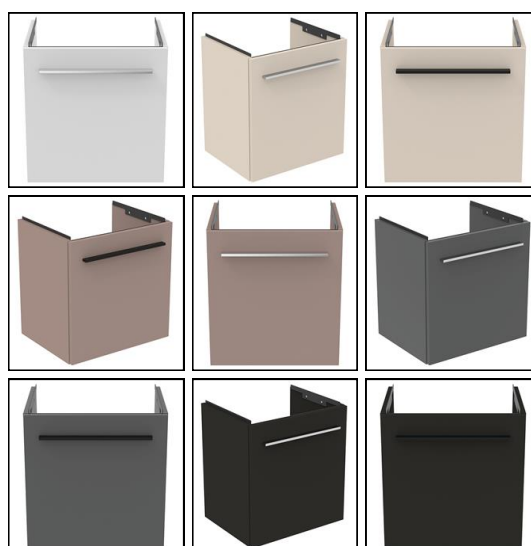
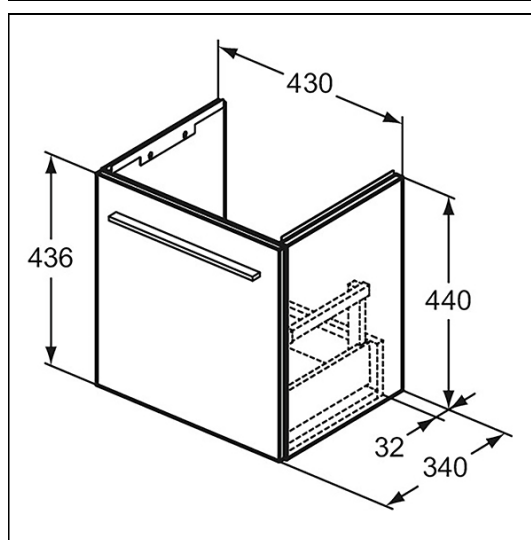

i.life S 1 Drawer Basin Unit

